



LS-Helios Séries

Ne craignez pas la nuit, Eclairez le futur.



Présentation **Produit**

- Aspect lisse et conception type Ligne.
- Jusqu'à 100 000 hrs @ L70, Faibles coûts de maintenance
- Peut être installée Horizontalement ou Verticalement avec un angle ajustable de $\pm 15^\circ$.
- Degré de protection : IP66 et IK08.
- Ouverture sans outil pour accès compartiment driver.
- Coque monobloc ADC12 en fonte d'aluminium haute pression pour une haute dissipation.
- Verre trempé haute résistance et haute performance de transmission de la lumière.
- La conception ouverte entre la source lumineuse et le compartiment driver , améliore le débit d'air et la dissipation thermique
- Type I/II/III/IV/V : différents types de distribution lumineuse pour répondre aux différentes configurations routières
- Sortie optique stable sans effet stroboscopique et facteur de puissance 0.95 contribuant à la stabilité du réseau électrique.

Zones Application

- Zones urbaines et résidentielles
- Zones pédestres
- Routes principales, secondaires...
- Zones de parking..
- Pistes cyclables
- Sentiers



| Données Produit | | | | | | | | |
|-----------------------|---|-------------|-------------|-----------------------------------|-------------|-------------|-------------|-------------|
| Références | LS-20W-SS | LS-30W-SS | LS-50W-SS | LS-60W-SS/S | LS-80W-S | LS-100W-S | LS-120W-S | LS-150W-M |
| Puissance | 20W | 30W | 50W | 60W | 80W | 100W | 120W | 150W |
| Efficacité lumineuse | 150lm/w | 150lm/w | 150lm/w | 150lm/w | 150lm/w | 150lm/w | 150lm/w | 150lm/w |
| Flux Lumineux | 3000lm | 4500lm | 7500lm | 9000lm | 12000lm | 15000lm | 18000lm | 22500lm |
| Dimensions (mm) | 498x180x115 | 498x180x115 | 498x180x115 | 498x180x115(SS) 629x250x125(S) | 629x250x125 | 629x250x125 | 629x250x125 | 698x280x115 |
| Données Electriques | | | | | | | | |
| Tension Alimentation | 100-265Vac / 50-60Hz | | | | | | | |
| LED | Lumileds | | | | | | | |
| CCT | 2700-6000K | | | | | | | |
| CRI | Ra>80 | | | | | | | |
| Driver | DONE/ Meanwell /.... | | | | | | | |
| THD | <15% | | | | | | | |
| Facteur de puissance | PF > 0.95 | | | | | | | |
| Données Générales | | | | | | | | |
| Index IP | IP66 | | | | | | | |
| Index IK | IK08 | | | | | | | |
| Diamètre Montage | 50mm /60mm (défaut) | | | | | | | |
| Matériau | Aluminium moulé haute pression | | | | | | | |
| Couleur boîtier | RAL9007 (autre sur demande)) | | | | | | | |
| Matériau protection | Poly-carbonate résistant UV | | | | | | | |
| Environnement | -20°C ~ +50°C , 10% ~90% HR | | | | | | | |
| Durée de vie L70/25°C | > 100 000 hrs | | | | | | | |
| Type de montage | Top ou crosse , vertical ou horizontal , ajustement ±15° | | | | | | | |
| Dimmer | 1-10V / Timer / Dali | | | | | | | |
| Classe de protection | Classe I (défaut) / Classe II | | | | | | | |
| Standarts | CE, RoHS, ENEC, CB, LM79, LM80, TM-21 , IP66 , IK08 , | | | | | | | |
| Options sur demande | Compatible Solaire, Socle NEMA (3/5/7 broches), socle ZHAGA , Couvercle court, Photo-cellule, Détecteur , NTC, OLC, DALI Dimmer | | | | | | | |
| Tolérances | Watt:±10%, CCT ±500K, Efficacité lumineuse : ±5% | | | | | | | |

Note : La gamme Helios existe aussi en version 200lm/w (sur demande)

OPTIONS Accessoires >>>



Photo-cellule



Couvercle court

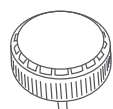

 Socle NEMA
(3 /5 /7broches)

 Détecteur
de mouvement

Contrôleur Intelligent

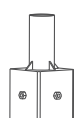
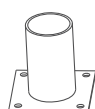

Connecteur couteau



 Adaptateur
"80-60mm"

 Adaptateur
"60-40mm"

 Adaptateur
Carré vers Rond

"T" Type

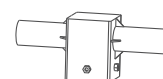

"L" Type



"2" in "1"

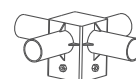

"4" in "1"



Version 3030

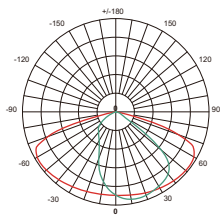

T2S53001

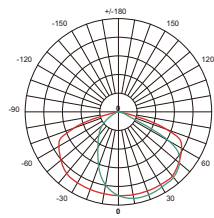

T3S53002

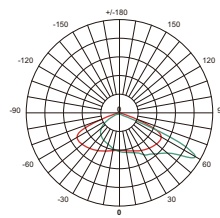

T3S53003

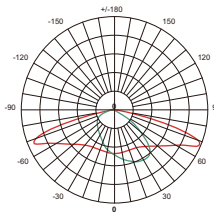

T2M53007

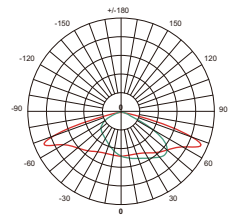

T3M53009

Version 5050

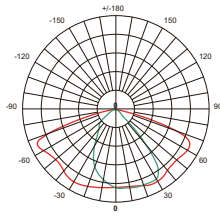

T2S55004

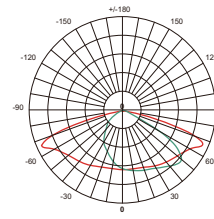

T3M55005

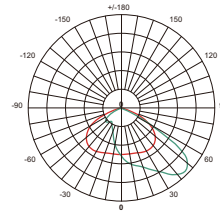

T3S55006

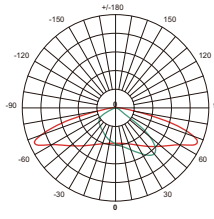

T2M55008

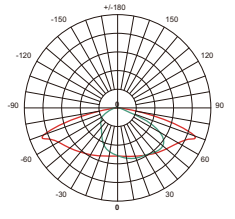

T3M55010

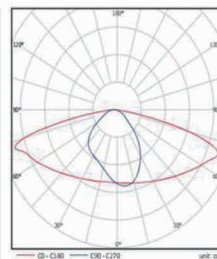
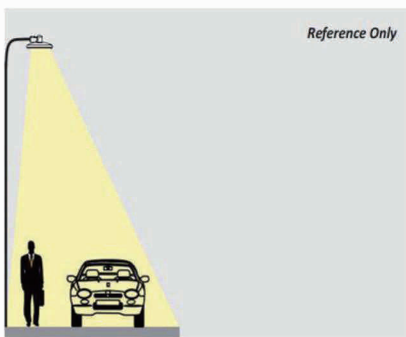

1M

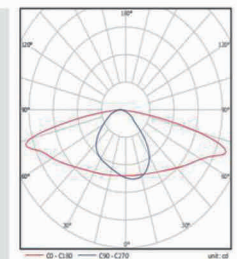
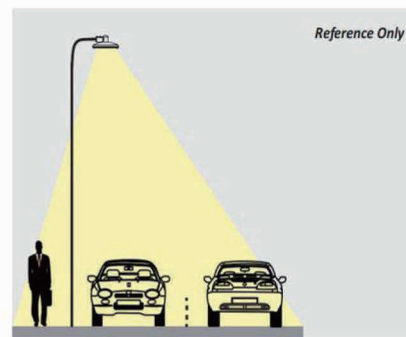

2M

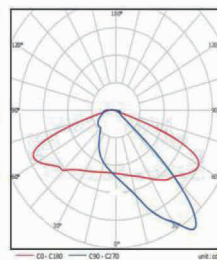
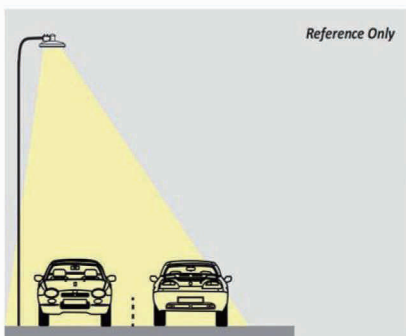

2M BLS

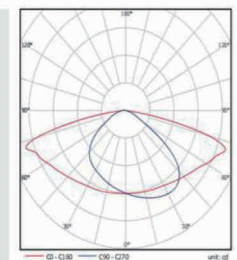
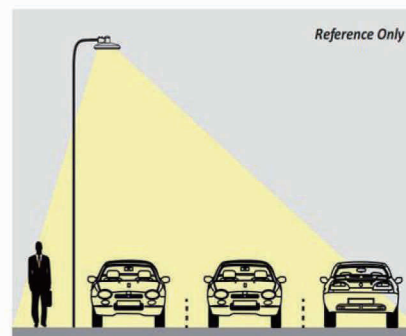

3M

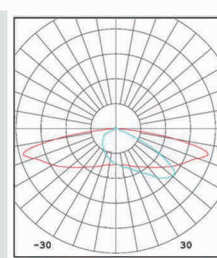
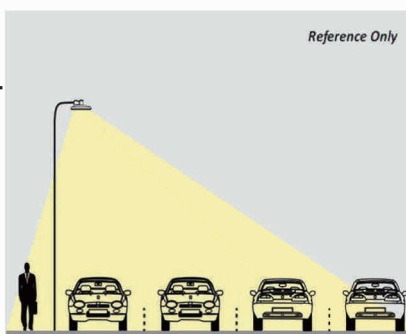

4M

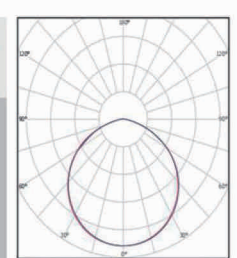
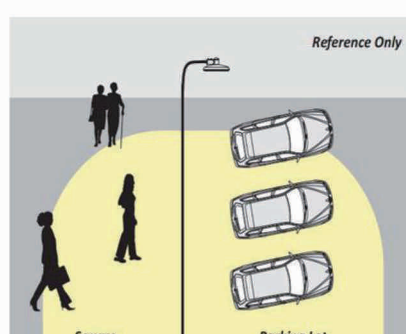

5S

INSTALLATION POLYVALENTE

OPTIQUES POLYVALENTS

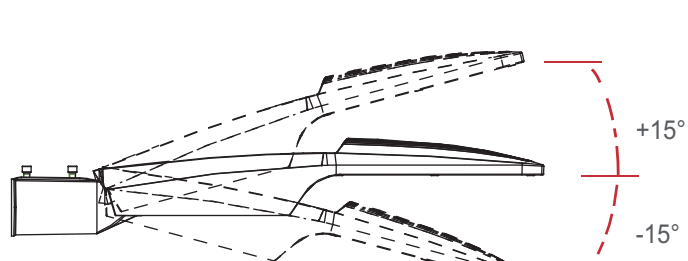

◆ INSTALLATION HORIZONTALE
Inclinaison $\pm 15^\circ$

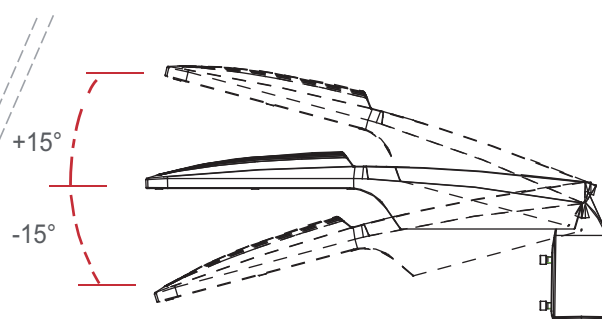

◆ INSTALLATION VERTICALE
Inclinaison $\pm 15^\circ$

La Lanterne SL-HELIOS dispose de plusieurs puissances et optiques qui permettent de s'adapter à différentes hauteurs et méthodes de montage. .

PRODUIT Détails >>>

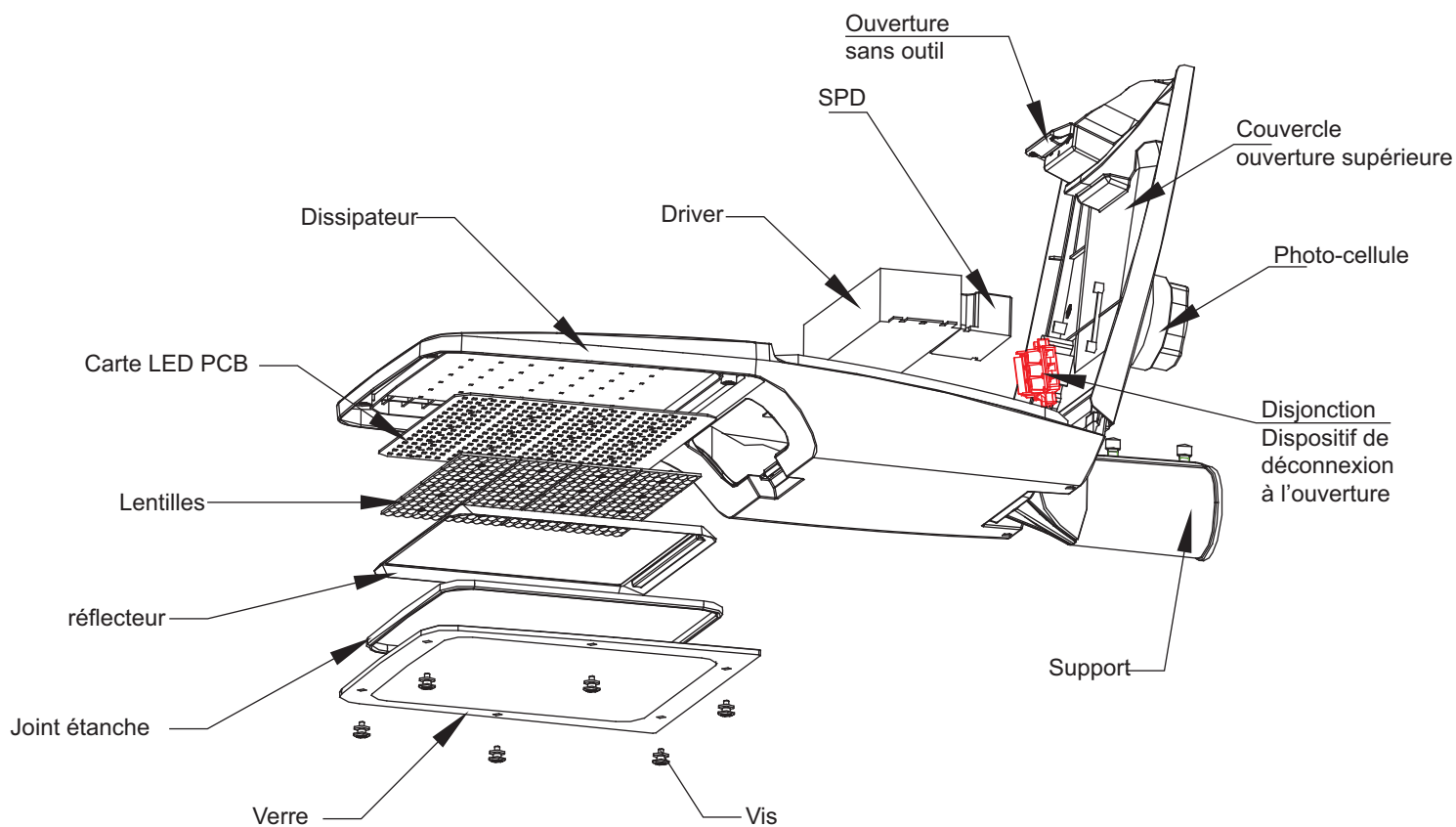

Nous assurons un service de simulation sur :

- AGI32
- Calculux
- Dialux/EVO

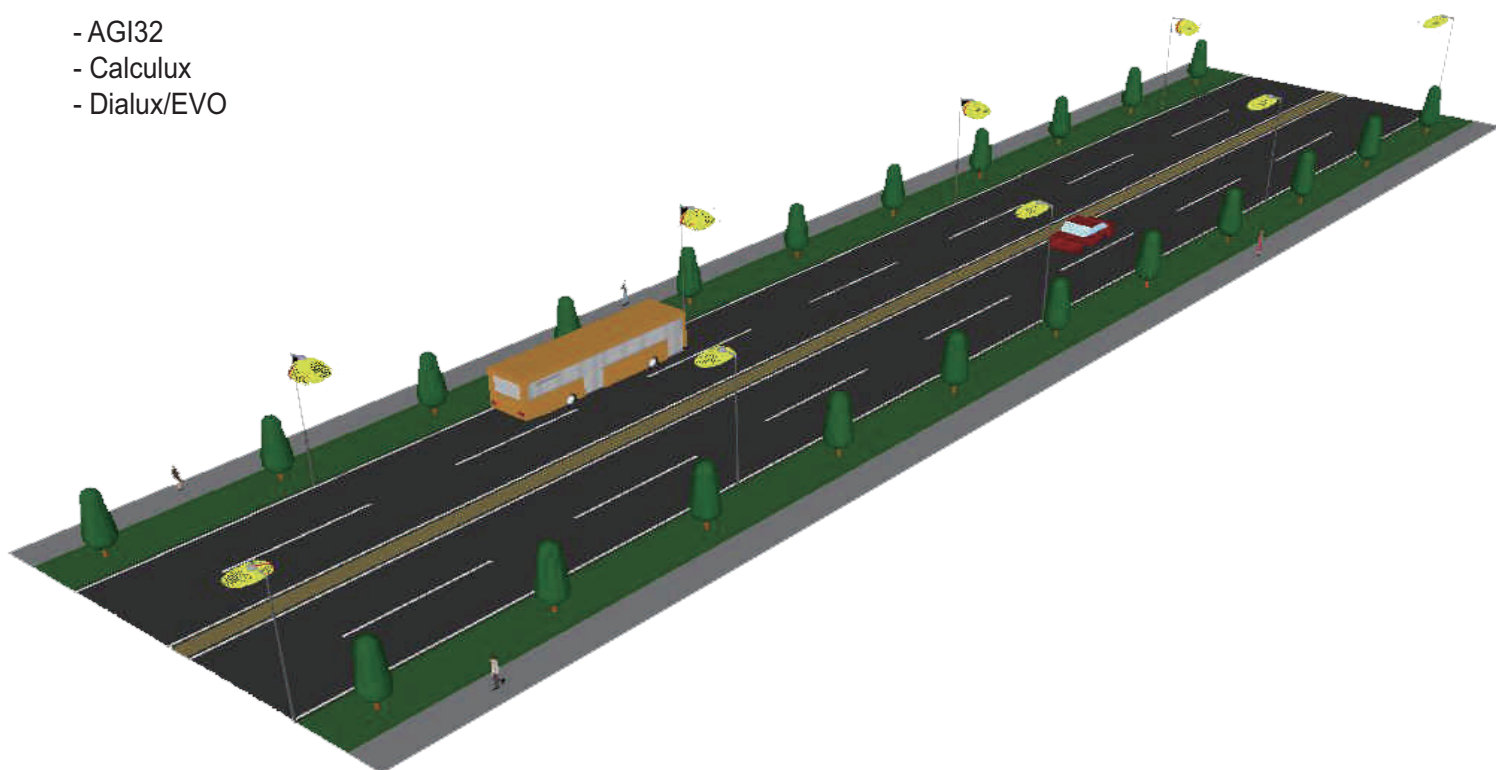

Dimensions >>>

| Informations luminaire | | |
|------------------------|-------------|-----------------|
| Version | AxBxC(mm) | Poids Net (Kg) |
| SS | 498x180x115 | 3.2 |
| S | 629x250x125 | 5.0 |
| M | 698x280x128 | 6.38 |

| Conditionnement | | | | |
|-----------------|-------------|-----------------|------------------------|------------------------|
| Version | AxBxC(mm) | Poids Brut (Kg) | Quantité Container 20' | Quantité Container 40' |
| SS | 550x230x180 | 3.8 | 1220pcs | 2950pcs |
| S | 680x300x180 | 5.6 | 750pcs | 1850pcs |
| M | 750x330x180 | 7.2 | 620pcs | 1520pcs |

